

TOUCHSCREEN TABULATION	
PART NUMBER	TYPE
5RB004G	CLEAR
5RB004N	ANTI GLARE

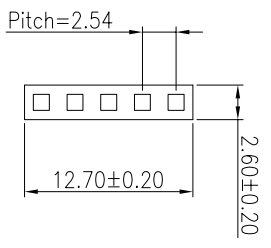

HOUSING

CONNECTOR PINOUT	
PIN NO.	DESIGNATION
1	RT
2	RL
3	SG
4	LT
5	LL

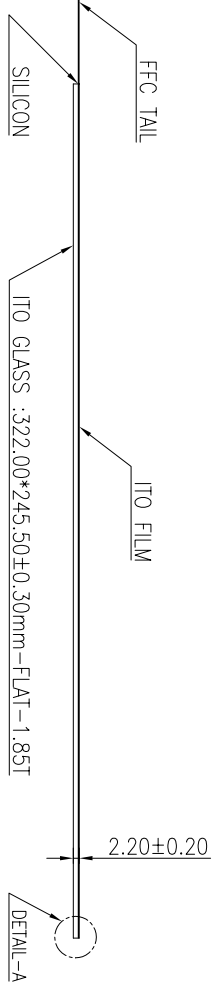
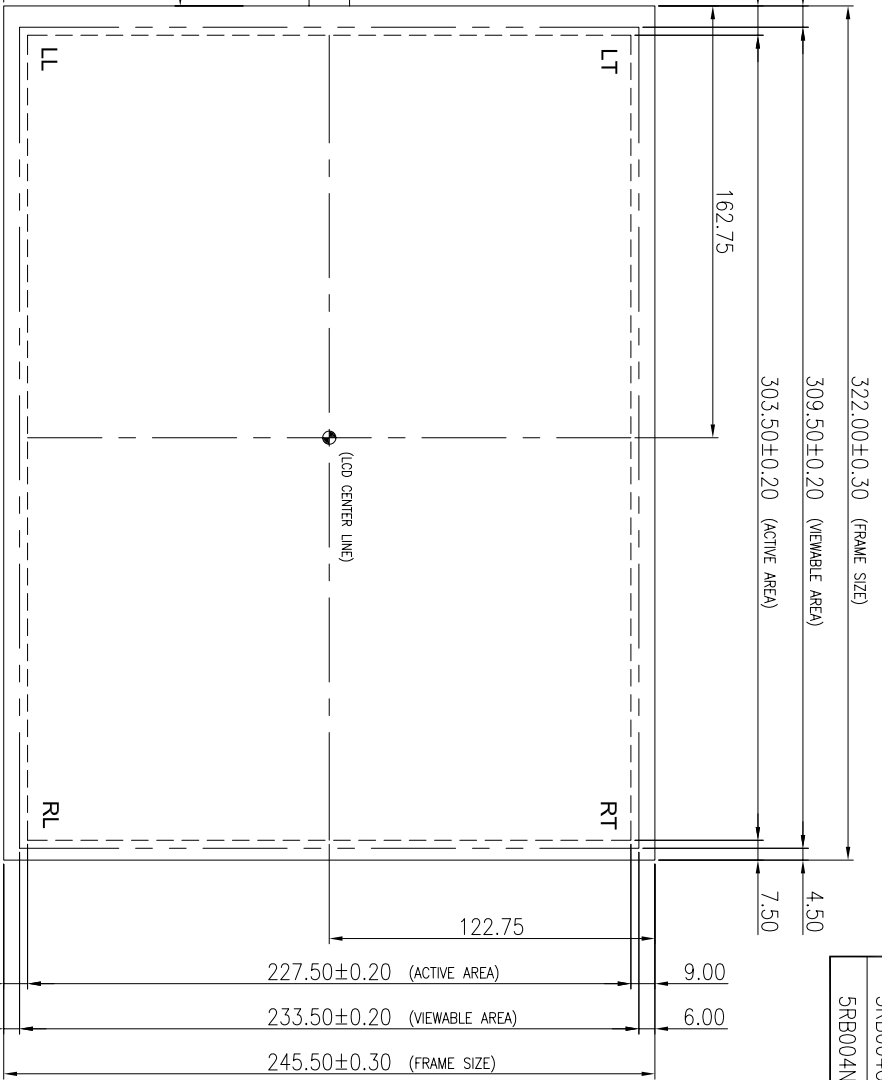
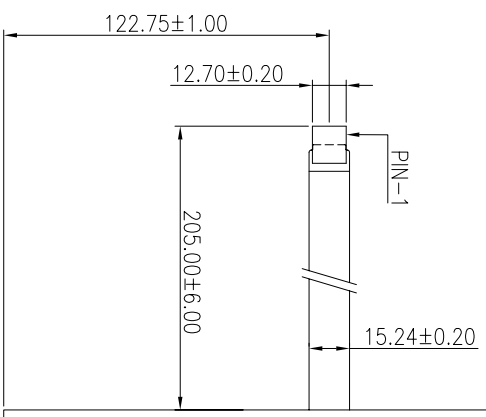
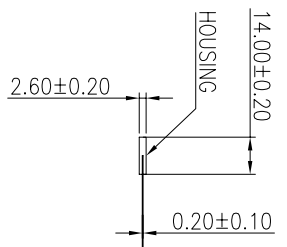
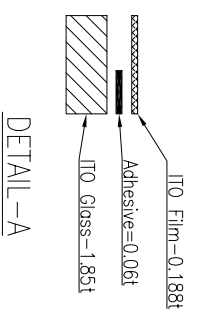
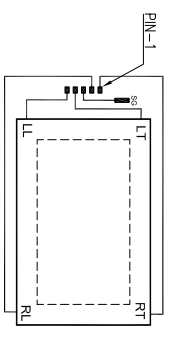

HIGGSTEC INC.

DESCRIPTION	WD-TR5-0129	DATE	DEC. 24, 2007	APPROVED	Rev.	A
MODEL	T150S-5RB004X-0A18R0-200FH	SCALE	-/-	DESIGN	Study	Page of
PART NO.		UNIT	mm.	DRAWING	Revised	B-Page of